



ASSEMBLY INSTRUCTIONS INSTRUCCIONES DE ENSAMBLE

CHEST OF DRAWERS 3 LEVELS CAJONERO 3 NIVELES

REFERENCES INFINITY / ECLYPSE / REFERENCIAS INFINITY / ECLYPSE



/ Assembly Parts

/ Piezas de Ensamble

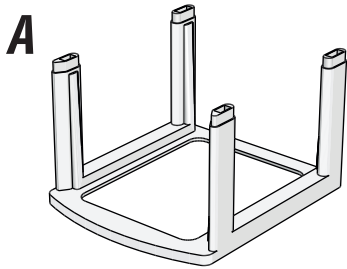

Frame / Armazón X3

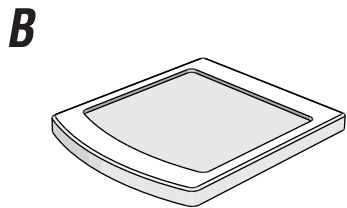

Cover / Tapa X1

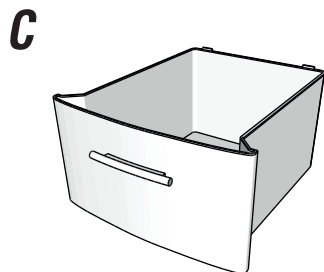

Drawer / Cajón X3

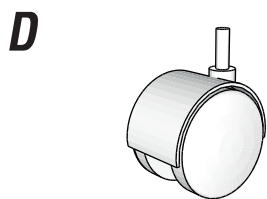

Caster Wheels / Rodachines X4

1

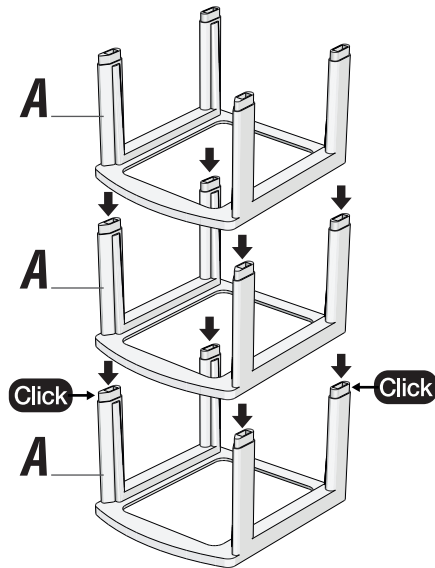

2

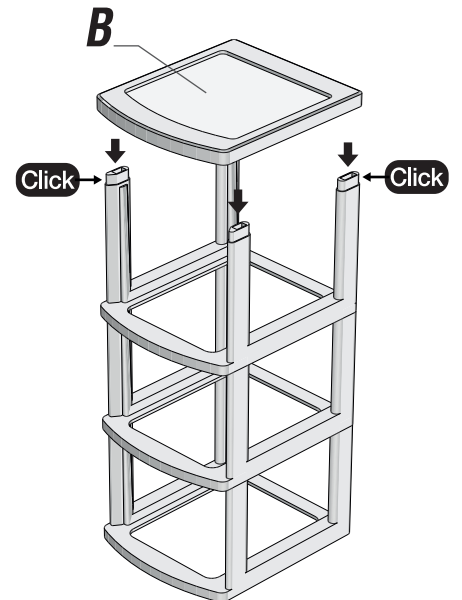

3

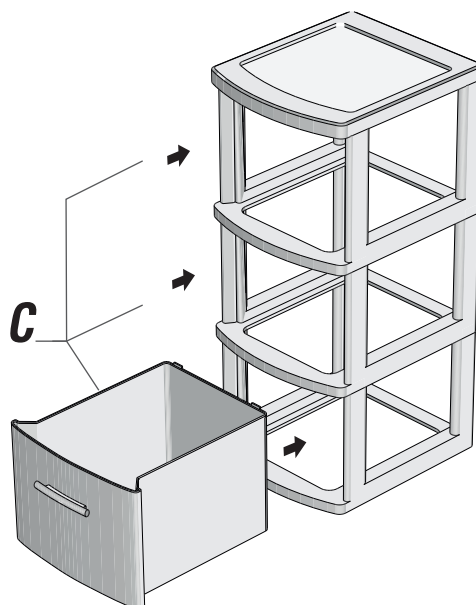

4

